



**PILOT CONTROLLED CHECK VALVES**  
**CPT / CPG-03 / 06 / 10 (3/8,3/4,1-1/4)**  
**DECOMPRESSION TYPE**  
**PILOT CONTROLLED CHECK VALVES**  
**CPDT / CPDG-03 / 06 / 10 (3/8,3/4,1-1/4)**  
**Threaded Connections / Sub-plate Mounting**

**DIRECTIONAL CONTROLS**

**Up to 25 MPa (3630 PSI), 600 L/min (159 U.S.GPM)**

These check valves allow flow in one direction and prevent flow in the reverse direction, until operated by pilot pressure to allow free reverse flow. The specified cracking pressure is required to open the valve to allow free flow direction.

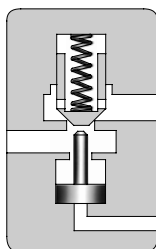

Graphic Symbols

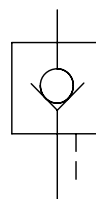

Internal Drain Type

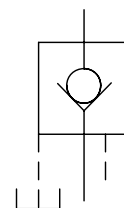

External Drain Type

**Specifications**

Model Numbers		Rated Flow* L/min (U.S.GPM)	Max. Operating Pres. MPa (PSI)	Cracking Pres. MPa (PSI)	Approx. Mass kg (lbs.)
Threaded Connection	CPT/CPDT-03-*-50*	40 (10.6)	25 (3630)	0.04 (6)	3.0 (6.6)
	CPT/CPDT-06-*-50*	125 (33)		0.2 (29)	5.5 (12.1)
	CPT/CPDT-10-*-50*	250 (66)		0.35 (50)	9.6 (21.2)
Sub-plate Mounting	CPG/CPDG-03-*-50*	40 (10.6)	25 (3630)	0.04 (6)	3.3 (7.3)
	CPG/CPDG-06-*-50*	125 (33)		0.2 (29)	5.4 (11.9)
	CPG/CPDG-10-*-50*	250 (66)		0.35 (50)	8.5 (18.7)

★ Rated flow is the approximate flow rate, when there is a free flow pressure drop of maximum 0.3 MPa (44 PSI), the fluid has a specific gravity of 0.85 and a kinematic viscosity of 20 mm<sup>2</sup>/s (98 SSU), and the cracking pressure is 0.04 MPa (6 PSI).

**Model Number Designation**

F-	CP	T	03	-E	-04	-50	*
Special Seals	Series Number	Type of Connection	Valve Size	Drain Connection	Cracking Pres. MPa (PSI)	Design Number	Design Standards
<b>F:</b> Special Seals for Phosphate Ester Type Fluids (Omit if not required)	<b>CP:</b> Pilot Controlled Check Valve	<b>T:</b> Threaded Connection	03	<b>None:</b> Internal Drain	<b>04:</b> 0.04 (6)	50	<b>None:</b> Japanese Std. "JIS" <b>80:</b> European Design Std. <b>90:</b> N. American Design Std.
			06			50	
			10			50	
	<b>CPD:</b> Decompression Type Pilot Controlled Check Valve	<b>G:</b> Sub-plate Mounting	03	<b>E:</b> External Drain	<b>35:</b> 0.35 (50) <b>50:</b> 0.5 (70)	50	<b>None:</b> Japanese Std. "JIS" & European Design Std. <b>90:</b> N. American Design Std.
			06			50	
			10			50	

**Mounting Bolts**

Socket head cap screws in the table below are included.

Valve Model Numbers	Socket Head Cap Screw		Qty.
	Japanese Standard "JIS" & European Design Standard	N.American Design Standard	
CP*G-03	M10 × 45 Lg.	3/8-16 UNC × 1-3/4 Lg.	4
CP*G-06	M10 × 50 Lg.	3/8-16 UNC × 2 Lg.	4
CP*G-10	M10 × 55 Lg.	3/8-16 UNC × 2-1/4 Lg.	6

**Yuken can offer flanged connection valves described below.**

For details, contact us.

Model Numbers	Rated Flow L/min (U.S.GPM)	Max. Operating Pressure MPa (PSI)
CP*F-10-*-50*	250 (66)	25 (3630)
CP*F-16-*-50*	600 (159)	25 (3630)



#### Hydraulic Fluids

##### Fluid Types

Any type of hydraulic fluids listed in the table below can be used.

Petroleum base oils	Use fluids equivalent to ISO VG 32 or VG 46.
Synthetic fluids	Use phosphate ester or polyol ester fluid. When phosphate ester fluid is used, prefix "F-" to the model number because the special seals (fluororubber) are required to be used.
Water containing fluids	Use water-glycol fluid.

Note: For use with hydraulic fluids other than those listed above, please consult your Yuken representatives in advance.

##### Recommended Viscosity and Oil Temperatures

Viscosity ranging between 15 - 400 mm<sup>2</sup>/s (77 - 1800 SSU).

Oil temperatures between -15/+70°C (5 - 158°F).

Use hydraulic fluids which satisfy the recommended viscosity and oil temperatures given above.

##### Control of Contamination

Due caution must be paid to maintaining control over contamination of the hydraulic fluids which may otherwise lead to breakdowns and shorten the life of the valves. Please maintain the degree of contamination within NAS 1638-Grade 12. Use 25 μm or finer line filter.

#### Sub-plate

Valve Model Numbers	Japanese Standard "JIS"		European Design Standard		N. American Design Standard		Approx. Mass kg (lbs.)
	Sub-plate Model Numbers	Thread Size	Sub-plate Model Numbers	Thread Size	Sub-plate Model Numbers	Thread Size	
CP*G-03	HGM-03-20	Rc 3/8	HGM-03-2080	3/8 BSP.F	HGM-03-2090	3/8 NPT	1.6 (3.5)
	HGM-03X-20	Rc1/2	HGM-03X-2080	1/2 BSP.F	HGM-03X-2090	1/2 NPT	1.6 (3.5)
CP*G-06	HGM-06-20	Rc 3/4	HGM-06-2080	3/4 BSP.F	HGM-06-2090	3/4 NPT	2.4 (5.3)
	HGM-06X-20	Rc 1	HGM-06X-2080	1 BSP.F	HGM-06X-2090	1 NPT	3.0 (6.6)
CP*G-10	HGM-10-20	Rc 1-1/4	HGM-10-2080	1-1/4 BSP.F	HGM-10-2090	1-1/4 NPT	4.8 (10.6)
	HGM-10X-20	Rc 1-1/2	HGM-10X-2080	1-1/2 BSP.F	HGM-10X-2090	1-1/2 NPT	5.7 (12.6)

Sub-plates are available, specify the sub-plate model number from the table above. When sub-plates are not used, the mounting surface should have a good machined finish.

#### Instructions

##### Operation of internal and external drain types

When the outlet side P1 is directly connected to the tank in reversed free flow (Fig. a), the internal drain type is normally used. When the back pressure is applied to the outlet side P1 (Fig. b), be sure to use the external drain type.

##### Minimum pilot pressure characteristics

That depends on the pressure of the inlet side P2 in the reversed free flow.

This value can be determined from the characteristics chart.

##### Cautions on replacement of 20 design low cracking pressure type valves with 50 design valves.

In 20 design valve with cracking pressure of 0.035 MPa (5 PSI) (Code "5"), for closing the valve completely and certainly, it was necessary to introduce the pressurized oil into the drain port to push down the piston compulsory.

While in 50 design valve with cracking pressure of 0.04 MPa (6 PSI) (Code "6"), it has such structure that the valve can be closed completely and certainly without introducing the pressurized oil into the drain port. On the contrary, what is worse is that if the pressurized oil is introduced into the drain port, the oil acts towards the direction of opening the valve, which is very dangerous and has to be absolutely avoided. Therefore, please do not supply any pressurized oil into the drain port in case of using 50 design valve.

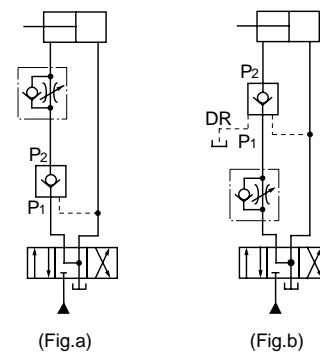

(Fig.a)

(Fig.b)

#### WARNING

The machinery, if misused due to failure to observe the "Cautions" on the left, may perform unforeseeable movements, resulting in a disastrous accident.

CPT/CPDT-03-\*\*-50/5080/5090  
CPT/CPDT-06-\*\*-50/5080/5090  
CPT/CPDT-10-\*\*-50/5080/5090

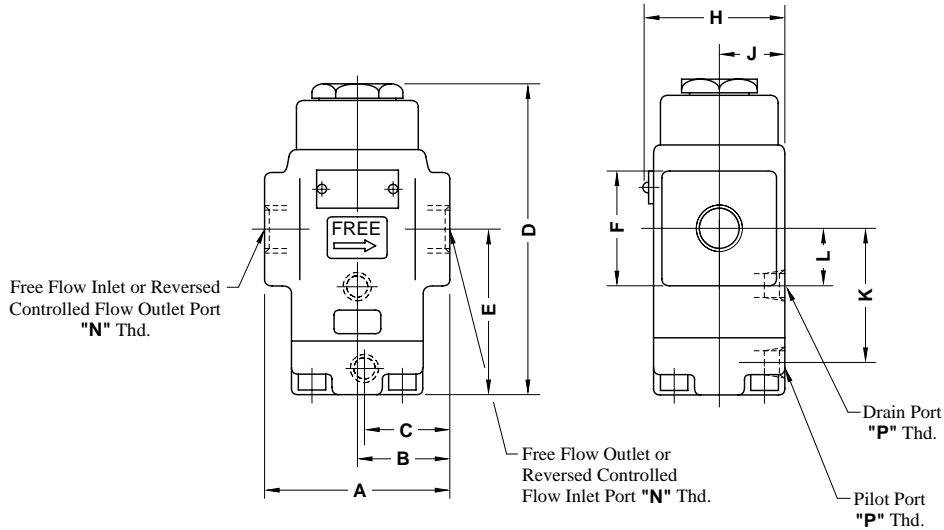

Model Numbers	Dimensions mm (Inches)										Thread Size	
	A	B	C	D	E	F	H	J	K	L	"N" Thd.	"P" Thd.
CPT/CPDT-03-**-50	80 (3.15)	40 (1.57)	39 (1.54)	150.5 (5.93)	84.5 (3.33)	38 (1.50) Dia.	60 (2.36)	29 (1.14)	67.5 (2.66)	26.5 (1.04)	Rc 3/8	Rc 1/4
CPT/CPDT-03-**-5080											3/8 BSP.F	1/4 BSP.F
CPT/CPDT-03-**-5090											3/8 NPT	1/4 NPT
CPT/CPDT-06-**-50	96 (3.78)	48 (1.89)	47 (1.85)	171.5 (6.75)	92.5 (3.64)	62 (2.44) SQ.	72 (2.83)	35 (1.38)	75.5 (2.97)	31 (1.22)	Rc 3/4	Rc 1/4
CPT/CPDT-06-**-5080											3/4 BSP.F	1/4 BSP.F
CPT/CPDT-06-**-5090											3/4 NPT	1/4 NPT
CPT/CPDT-10-**-50	140 (5.51)	70 (2.76)	64 (2.52)	203.5 (8.01)	113 (4.45)	80 (3.15) SQ.	82 (3.23)	40 (1.57)	96 (3.78)	43 (1.69)	Rc 1-1/4	Rc 1/4
CPT/CPDT-10-**-5080											1-1/4 BSP.F	1/4 BSP.F
CPT/CPDT-10-**-5090											1-1/4 NPT	1/4 NPT



CPG/CPDG-03-\*\*-\*\*-50/5090  
CPG/CPDG-06-\*\*-\*\*-50/5090

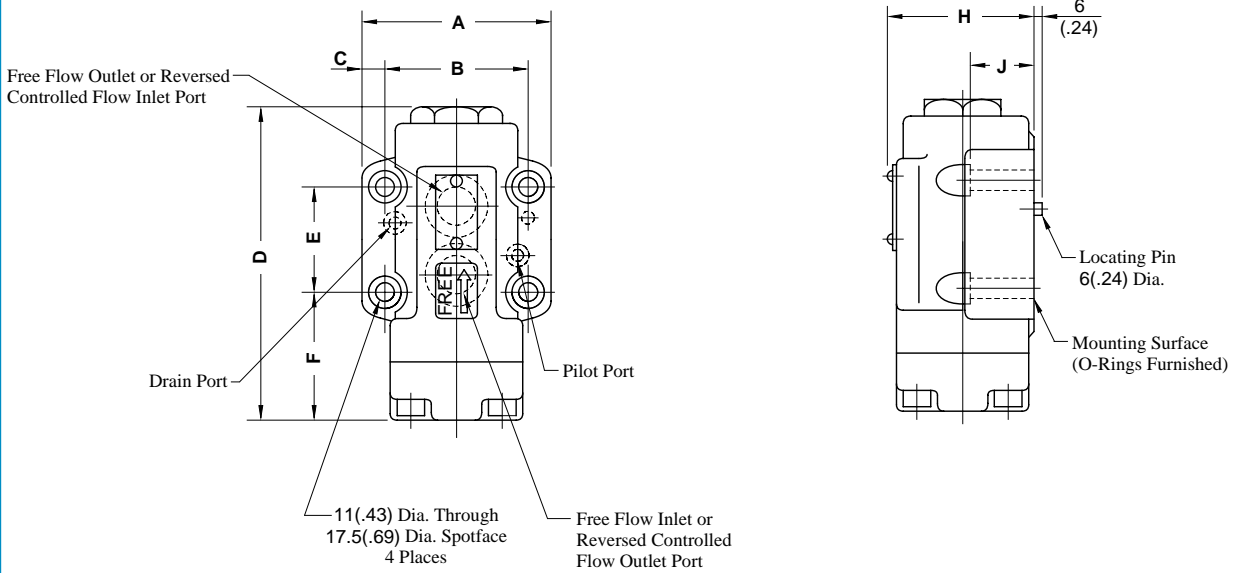

Model Numbers	Dimensions mm (Inches)								Mounting Surface
	A	B	C	D	E	F	H	J	
CPG/CPDG-03-**-**-50/5090	90 (3.54)	66.7 (2.63)	11.7 (.46)	150.5 (5.93)	42.9 (1.69)	66 (2.60)	62 (2.44)	30 (1.18)	ISO 5781-AG-06-2-A
CPG/CPDG-06-**-**-50/5090	102 (4.02)	79.4 (3.13)	11.3 (.44)	171.5 (6.75)	60.3 (2.37)	67.5 (2.66)	74 (2.91)	35 (1.38)	ISO 5781-AH-08-2-A

CPG/CPDG-10-\*\*-\*\*-50/5090

Mounting surface: ISO 5781-AJ-10-2-A

DIMENSIONS IN  
MILLIMETRES (INCHES)

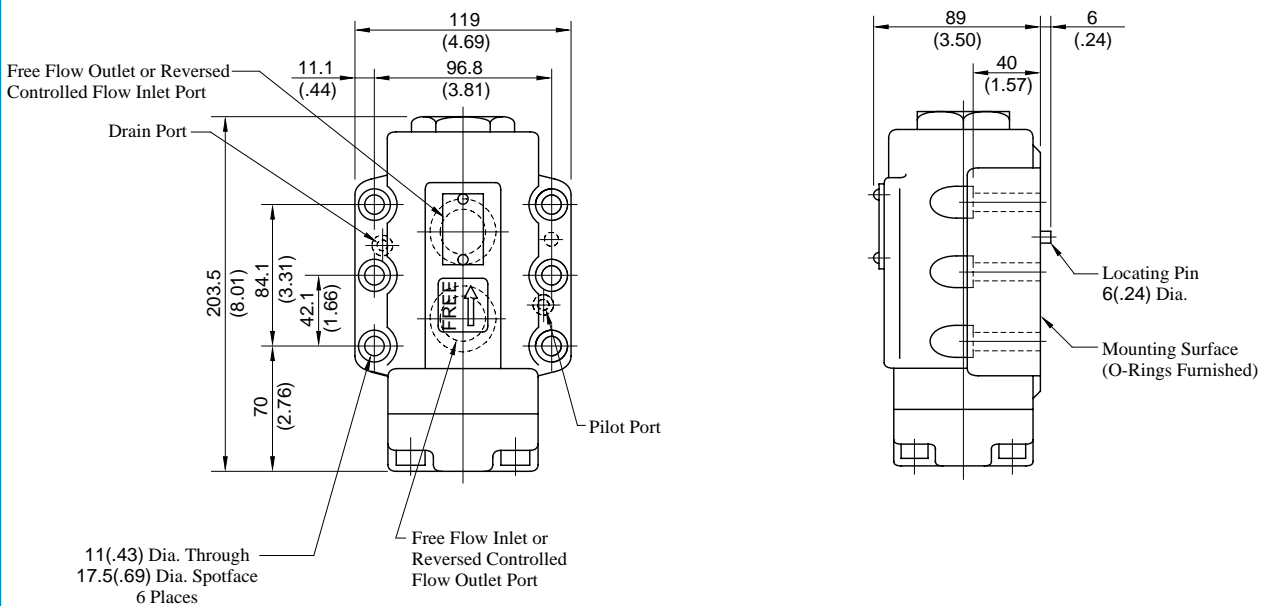

HGM-03-20/2080/2090  
HGM-03X-20/2080/2090

**DIMENSIONS IN  
MILLIMETRES (INCHES)**

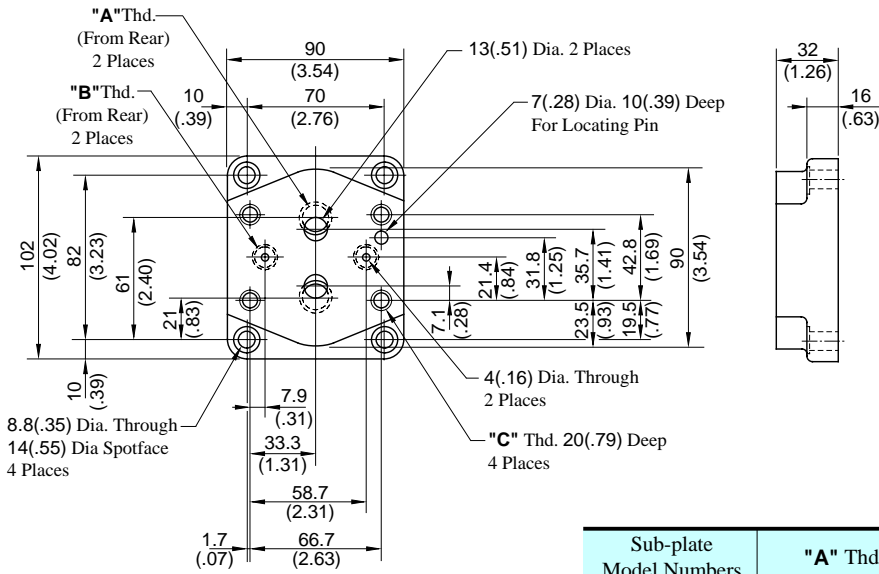

Sub-plate Model Numbers	"A" Thd.	"B" Thd.	"C" Thd.
HGM-03-20	Rc 3/8	Rc 1/4	M10
HGM-03X-20	Rc 1/2		
HGM-03-2080	3/8 BSP.F	1/4 BSP.F	
HGM-03X-2080	1/2 BSP.F		
HGM-03-2090	3/8 NPT	1/4 NPT	3/8-16 UNC
HGM-03X-2090	1/2 NPT		



#### HGM-06-20/2080/2090

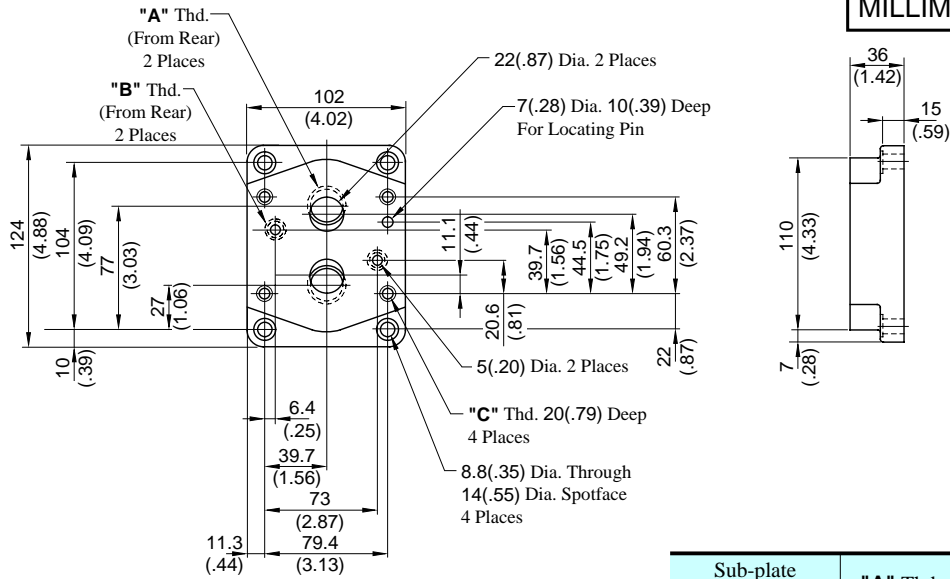

DIMENSIONS IN MILLIMETRES (INCHES)

Sub-plate Model Numbers	"A" Thd.	"B" Thd.	"C" Thd.
HGM-06-20	Rc 3/4	Rc 1/4	M10
HGM-06-2080	3/4 BSP.F	1/4 BSP.F	
HGM-06-2090	3/4 NPT	1/4 NPT	3/8-16 UNC

#### HGM-06X-20/2080/2090

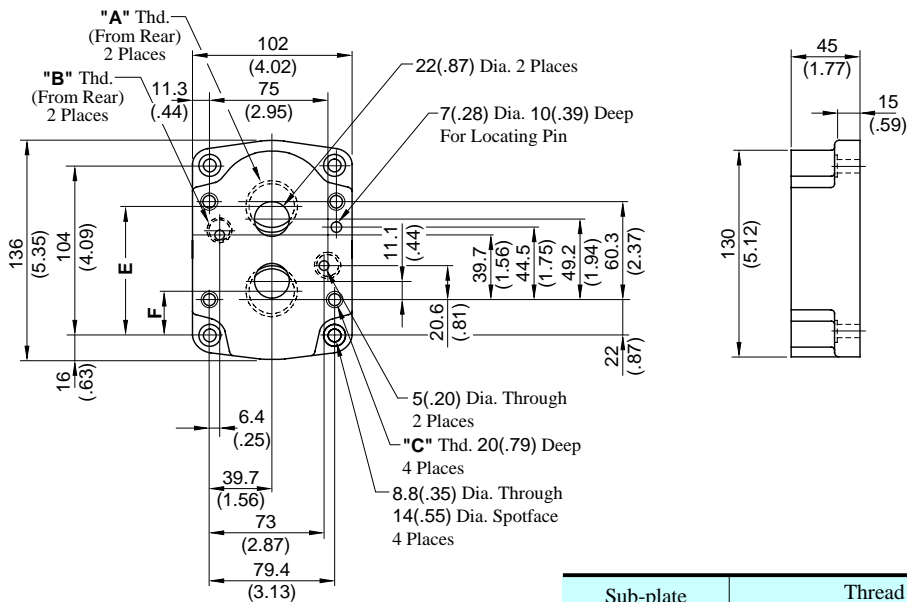

Sub-plate Model Numbers	Thread Size			mm (Inches)	
	"A" Thd.	"B" Thd.	"C" Thd.	E	F
HGM-06X-20	Rc 1	Rc 1/4	M10	82.3 (3.24)	22 (.87)
HGM-06X-2080	1 BSP.F	1/4 BSP.F		80 (3.15)	24 (.94)
HGM-06X-2090	1 NPT	1/4 NPT	3/8-16 UNC		

### HGM-10-20/2080/2090

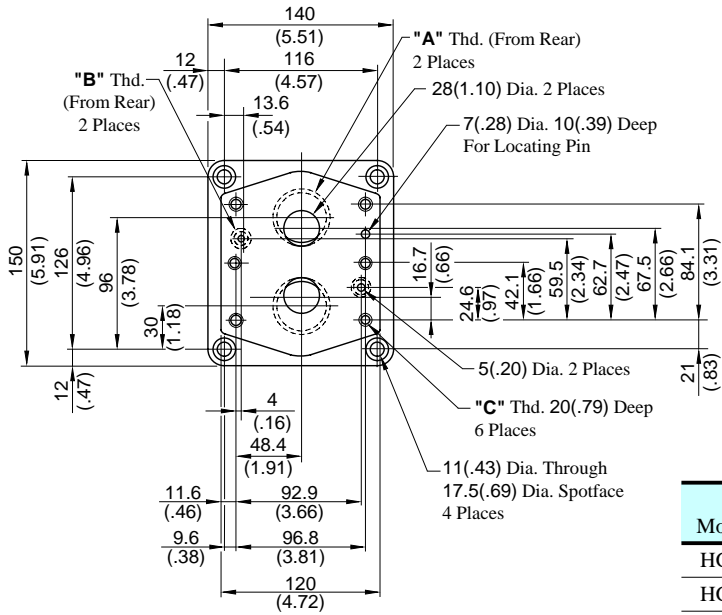

DIMENSIONS IN MILLIMETRES (INCHES)

Sub-plate Model Numbers	"A" Thd.	"B" Thd.	"C" Thd.
HGM-10-20	Rc 1-1/4	Rc 1/4	M10
HGM-10-2080	1-1/4 BSP.F	1/4 BSP.F	
HGM-10-2090	1-1/4 NPT	1/4 NPT	3/8-16 UNC

### HGM-10X-20/2080/2090

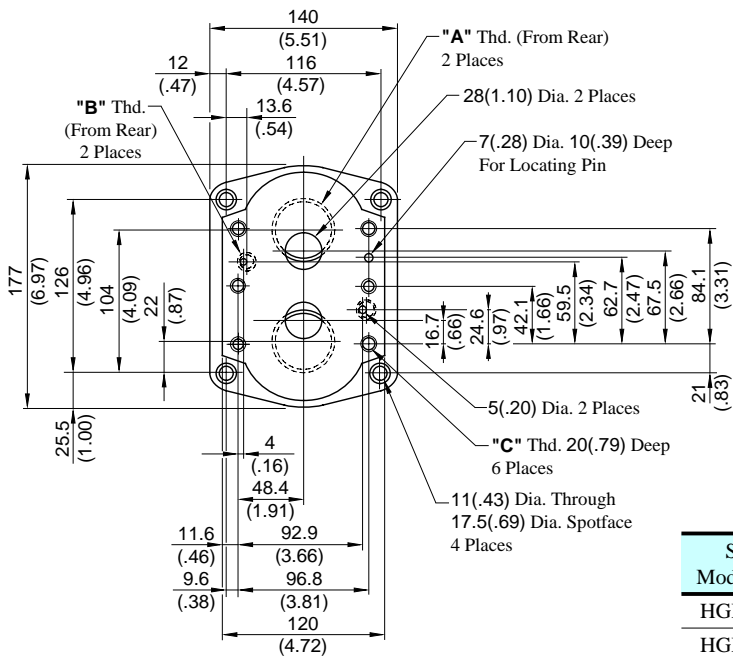

Sub-plate Model Numbers	"A" Thd.	"B" Thd.	"C" Thd.
HGM-10X-20	Rc 1-1/2	Rc 1/4	M10
HGM-10X-2080	1-1/2 BSP.F	1/4 BSP.F	
HGM-10X-2090	1-1/2 NPT	1/4 NPT	3/8-16 UNC



Hydraulic Fluid: Viscosity 30 mm<sup>2</sup>/s (141 SSU) , Specific Gravity 0.850

#### Pressure Drop

##### ● CPT-03, CPDT-03

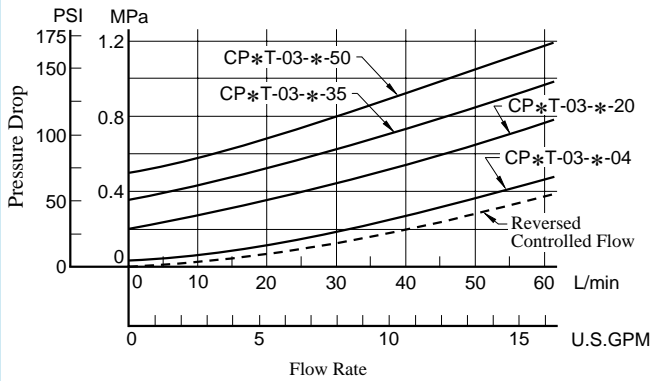

##### ● CPG-03, CPDG-03

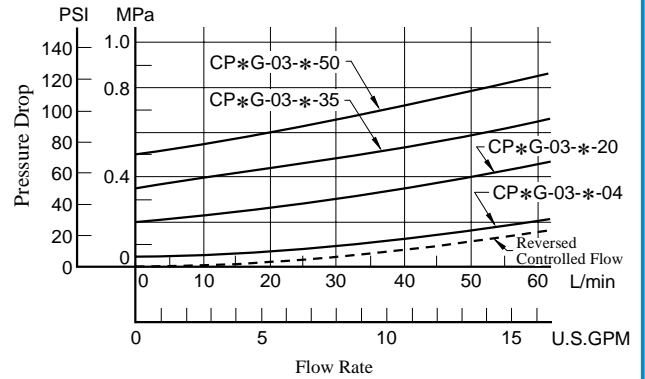

##### ● CPT-06, CPDT-06

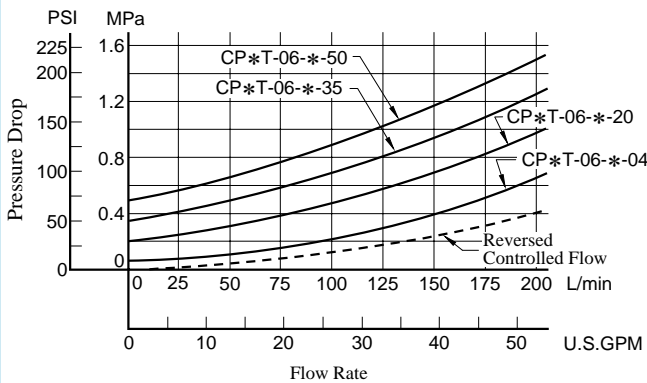

##### ● CPG-06, CPDG-06

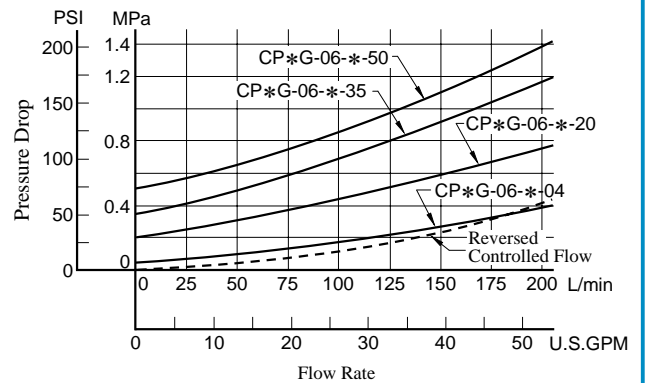

##### ● CPT-10, CPDT-10

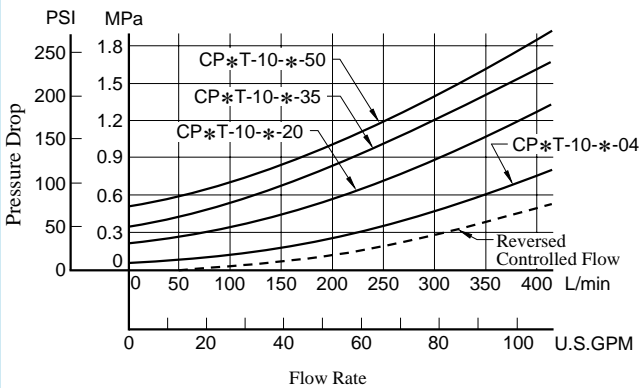

##### ● CPG-10, CPDG-10

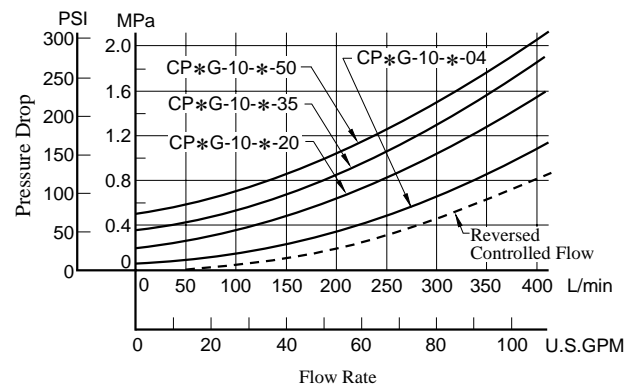

Hydraulic Fluid: Viscosity 30 mm<sup>2</sup>/s (141 SSU) , Specific Gravity 0.850

#### ■ Min. Pilot Pressure Chart

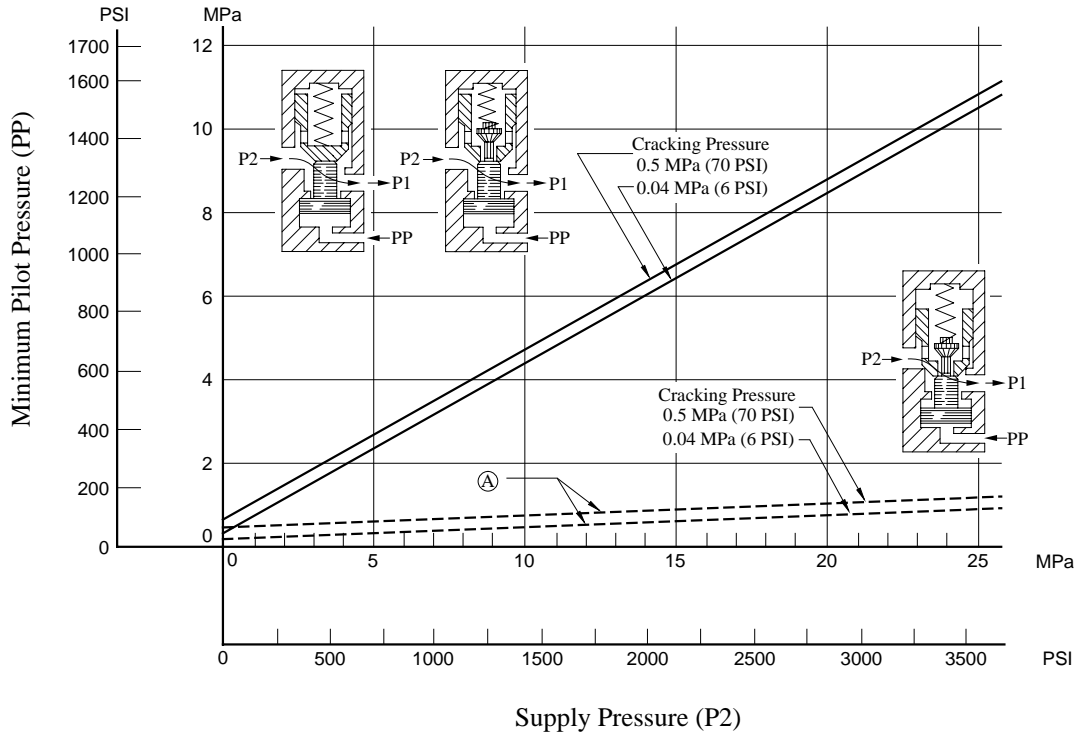

Ⓐ : Min. Pilot Pressure to open the Decompression Valve

#### ■ Pressure Drop for Reversed Controlled Flow Only when Decompression Valve is Opened

##### ● CPDT-03, CPDG-03

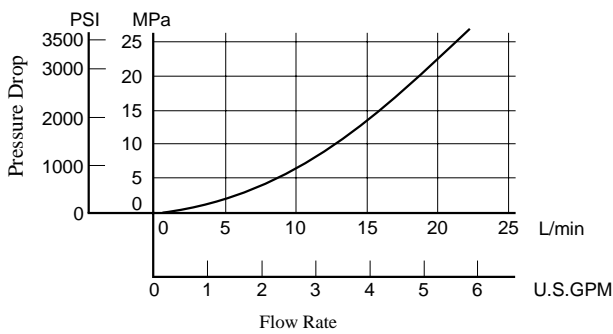

##### ● CPDT-06, CPDG-06

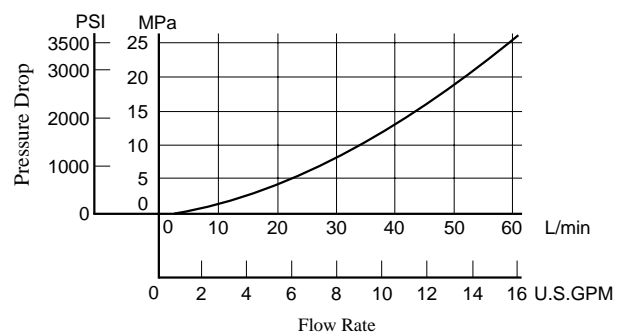

##### ● CPDT-10, CPDG-10

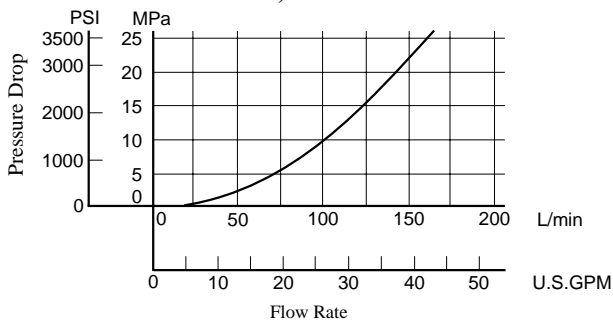

### Spare Parts List

CPT/CPDT-03-\*-50/5080/5090  
CPT/CPDT-06-\*-50/5080/5090  
CPT/CPDT-10-\*-50/5080/5090

### CAUTION

When making replacement of seals, please do it carefully after reading through the relevant instructions in the Operator's Manual.

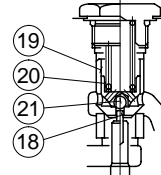
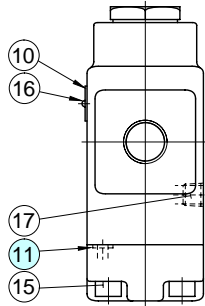
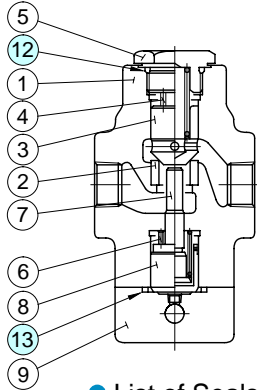

CPDT-03/06/10

#### List of Seals

Item	Name of Parts	Part Numbers			Qty.
		CPT/CPDT-03	CPT/CPDT-06	CPT/CPDT-10	
11	O-Ring	SO-NB-P7	SO-NB-P9	SO-NB-P9	1
12	O-Ring	SO-NB-P21	SO-NB-P29	SO-NB-P36	1
13	O-Ring	SO-NB-G25	SO-NB-P32	SO-NB-P42	1

Note: When ordering the seals, please specify the seal kit number from the table below.

CPG/CPDG-03-\*-50/5090  
CPG/CPDG-06-\*-50/5090  
CPG/CPDG-10-\*-50/5090

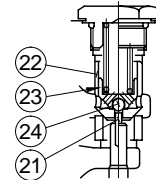
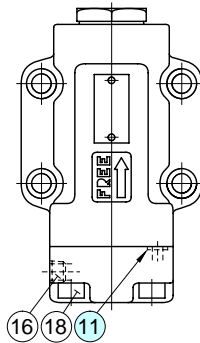
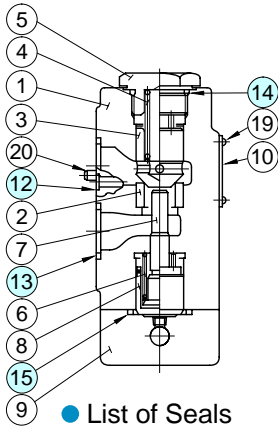

CPDG-03/06/10

#### List of Seals

Item	Name of Parts	Part Numbers			Qty.
		CPG/CPDG-03	CPG/CPDG-06	CPG/CPDG-10	
11	O-Ring	SO-NB-P7	SO-NB-P9	SO-NB-P9	1
12	O-Ring	SO-NB-P9	SO-NB-P9	SO-NB-P9	2
13	O-Ring	SO-NB-P18	SO-NB-P28	SO-NB-P32	2
14	O-Ring	SO-NB-P21	SO-NB-P29	SO-NB-P36	1
15	O-Ring	SO-NB-G25	SO-NB-P32	SO-NB-P42	1

Note: When ordering the O-Rings, please specify the seal kit number from the table below.

#### List of Seal Kits

Model Numbers	Seal Kit Numbers
CPT/CPDT-03-*-50/5080/5090	KS-CPT-03-50
CPT/CPDT-06-*-50/5080/5090	KS-CPT-06-50
CPT/CPDT-10-*-50/5080/5090	KS-CPT-10-50
CPG/CPDG-03-*-50/5090	KS-CPG-03-50
CPG/CPDG-06-*-50/5090	KS-CPG-06-50
CPG/CPDG-10-*-50/5090	KS-CPG-10-50